

HIGH  
NOLOGY®

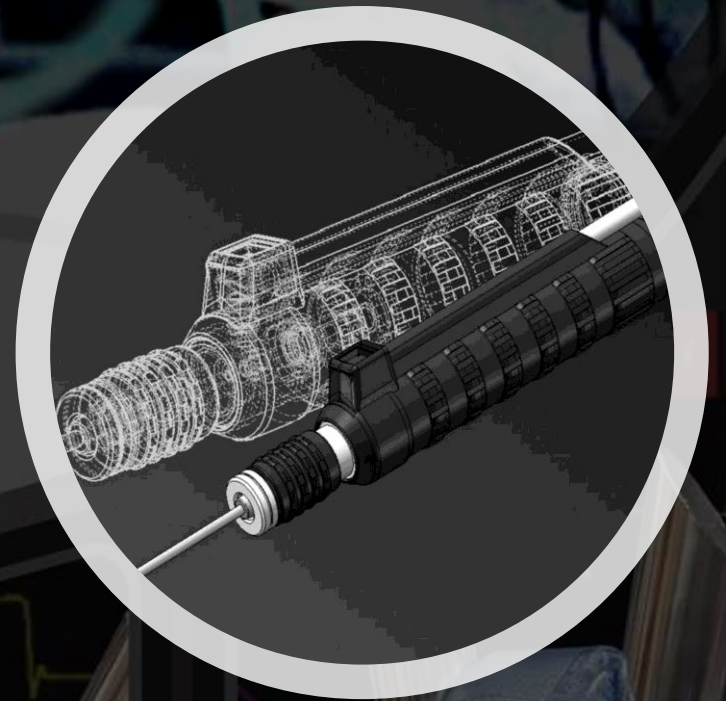

R&V HIGH  
TECHNOLOGY®

[www.ryvhightech.com](http://www.ryvhightech.com)



R&V  
Medical Equipments

Aprox needed torque:  
5 kgf / 15 cm  
Tidal volume : 600 ml  
Max Pressure : 30 cm H<sub>2</sub>O  
Frec. : 15 osc / min.



CUMPLIMOS CON LAS EXPECTATIVAS EN EL DESARROLLO DE  
PRODUCTOS DE ALTA TECNOLOGIA DESDE 1992



### **Políticas de calidad:**

Basada en tres pilares

1. Enfoque total hacia el cliente
2. Participación y trabajo en equipo
3. Mejoramiento continuo

### **Soporte:**

- Ingenieros y técnicos altamente calificados, especializados en Europa y USA.
- Contamos con sofisticados laboratorios de electrónica.

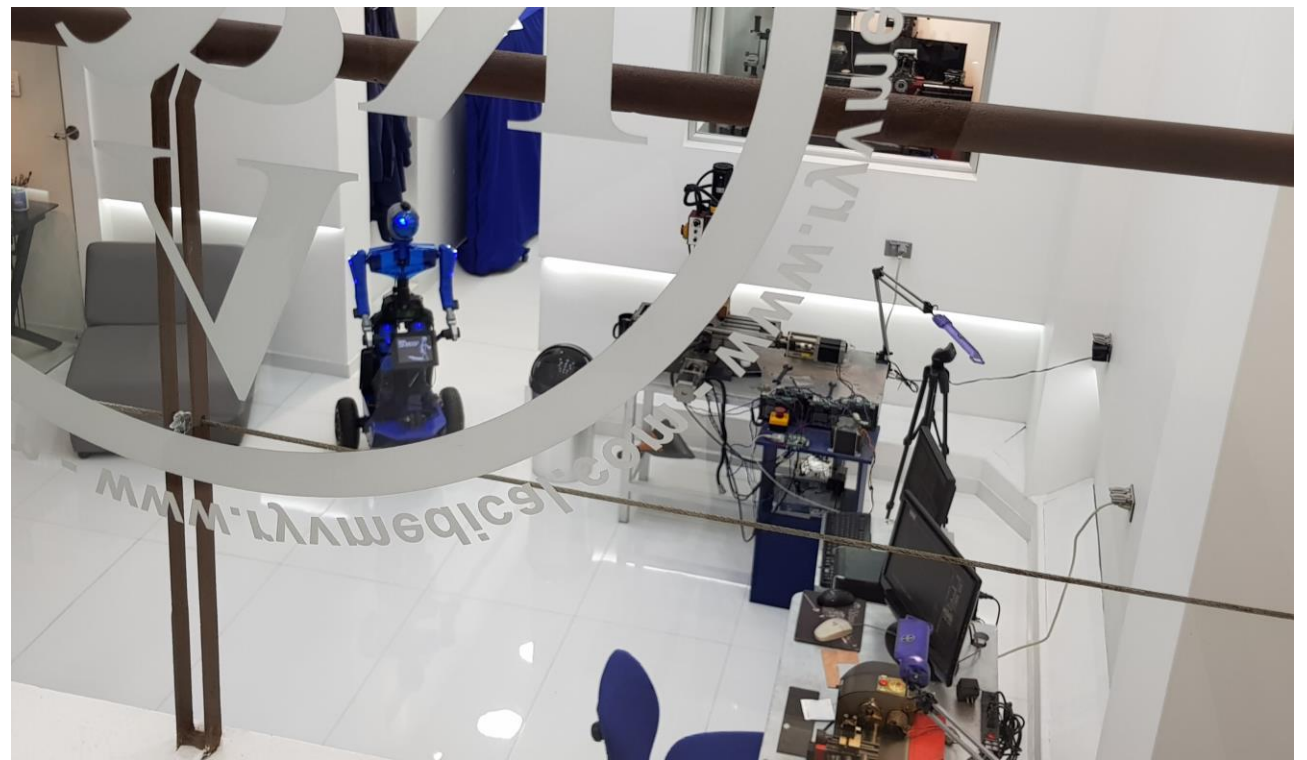

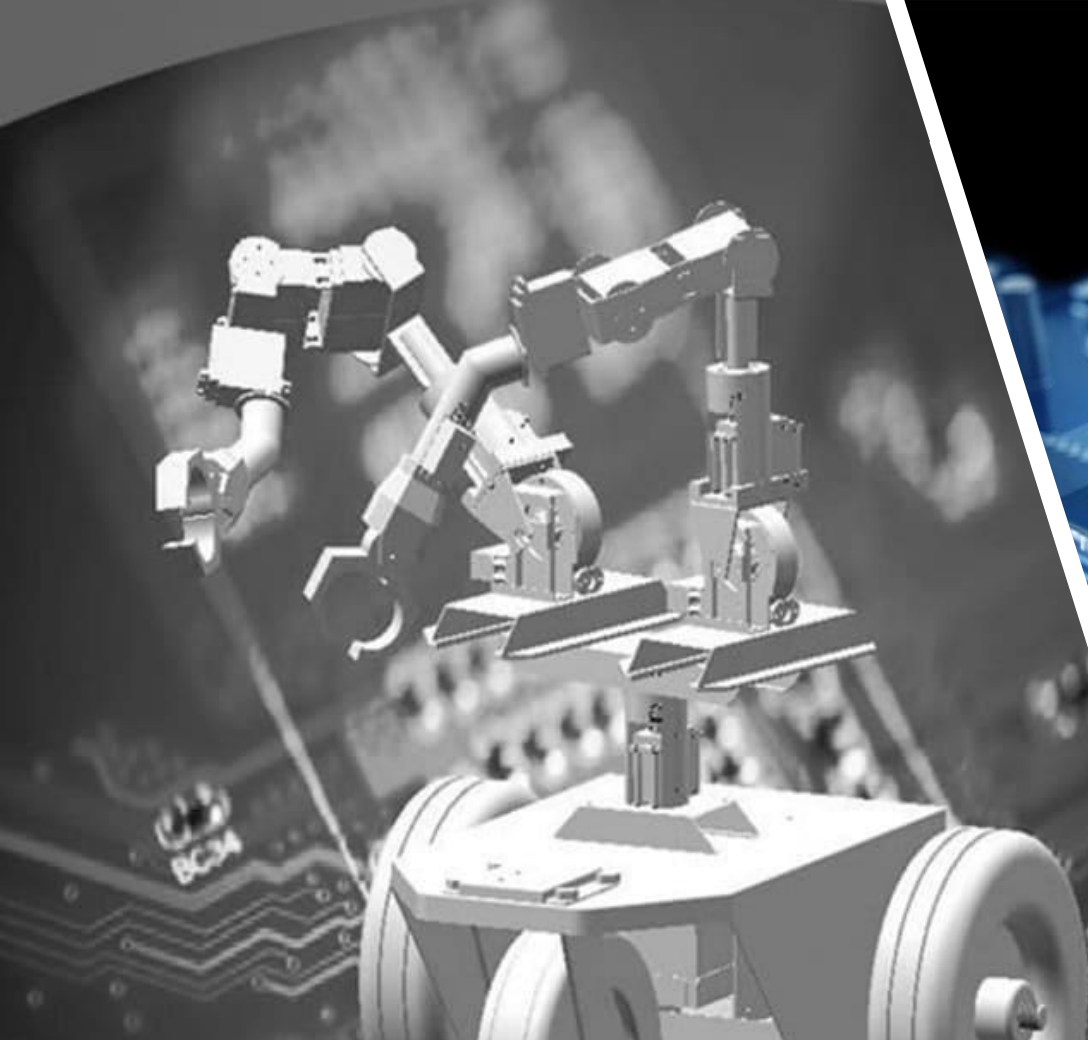

R&V HIGH TECHNOLOGY®



# ORTHOPEDICS



# LAPAROSCOPY

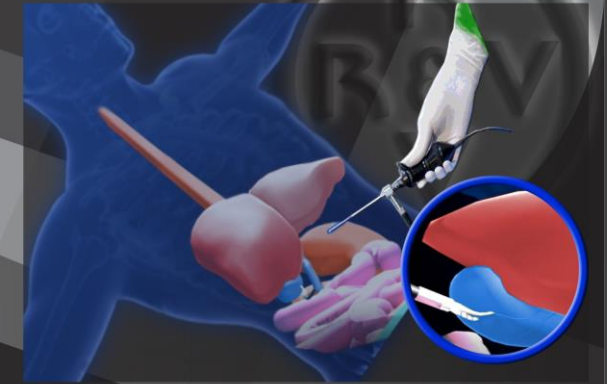

# PLASTIC SURGERY



EASIER, FASTER, SECURE AND BETTER RESULTS



# ORL



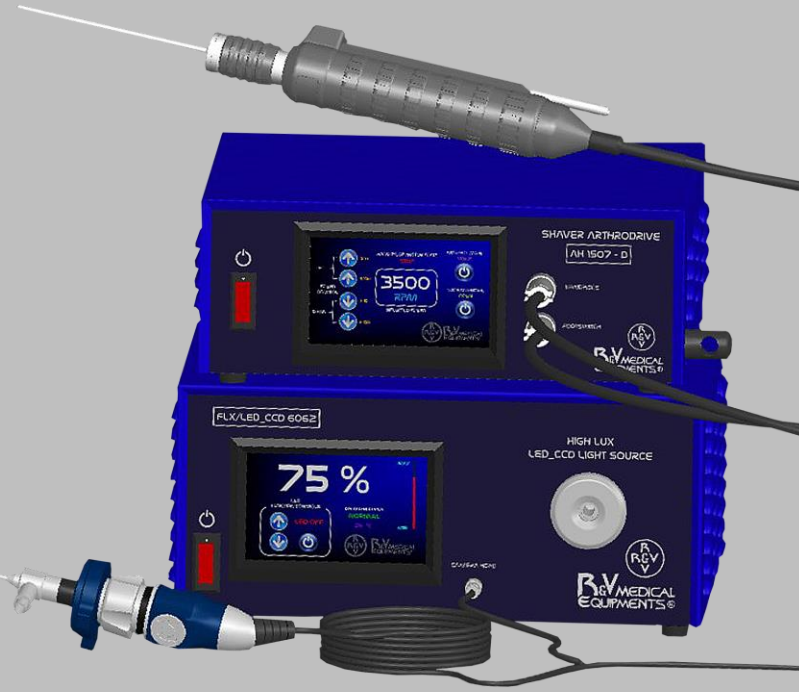

# ORTHOPEDICS

# LIPOSUCCION

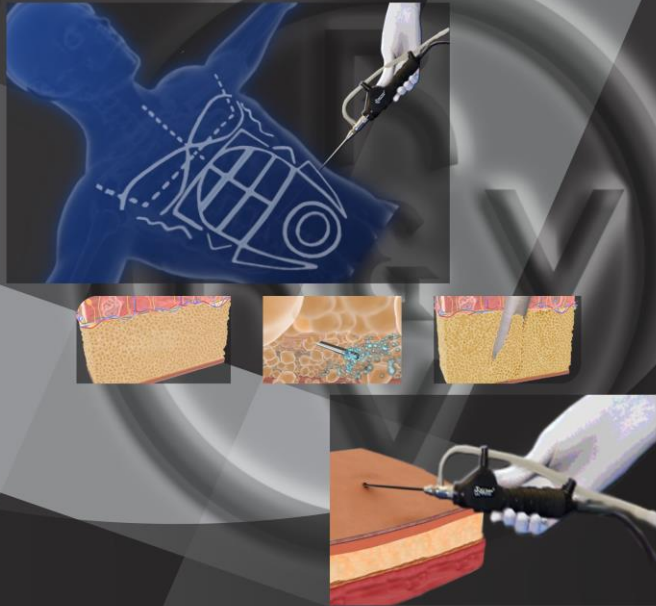

# FRONTOPLASTY



# PLASTIC SURGERY

# LAPAROSCOPY

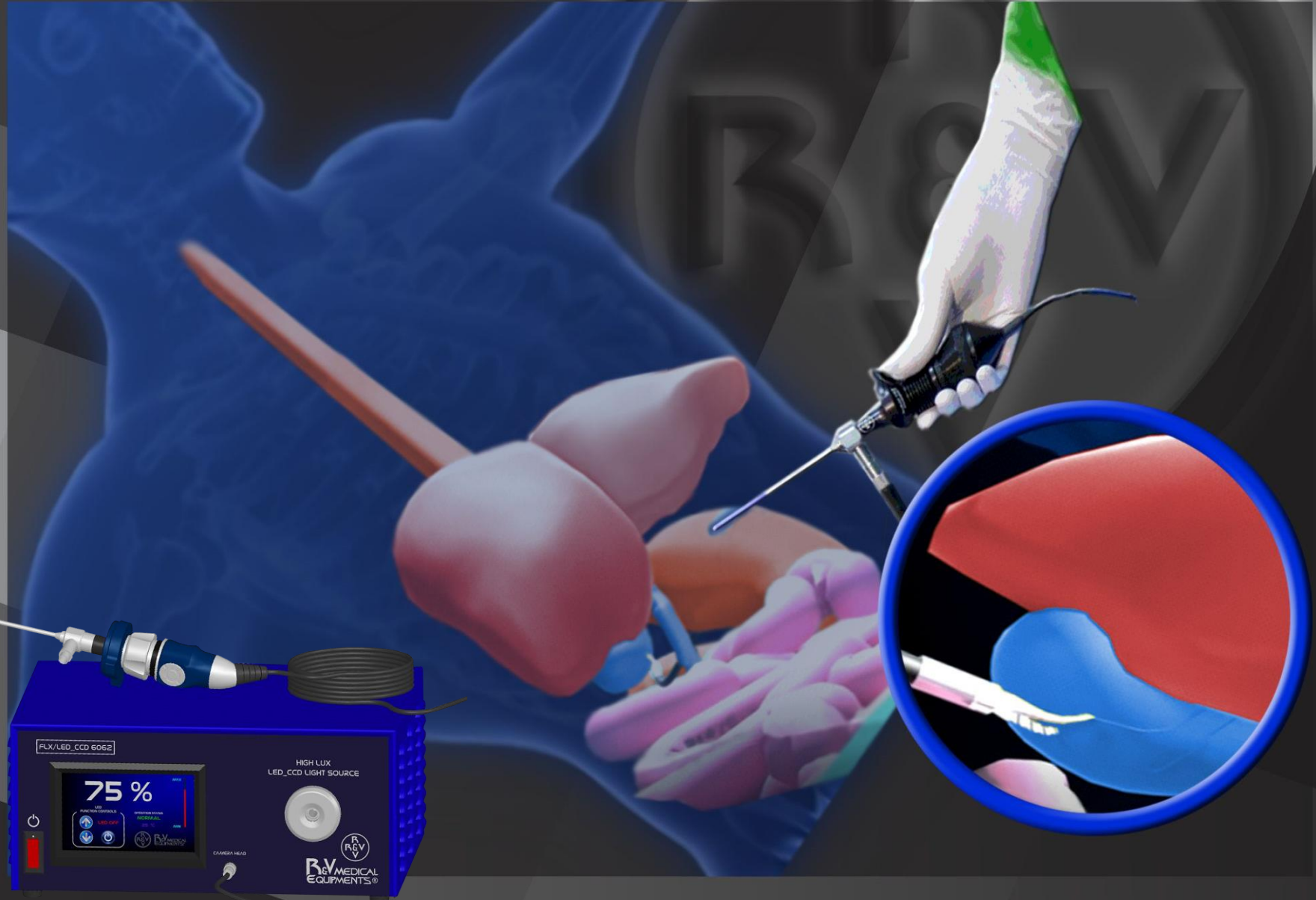

Nueva tecnología



# ORL

# ORL

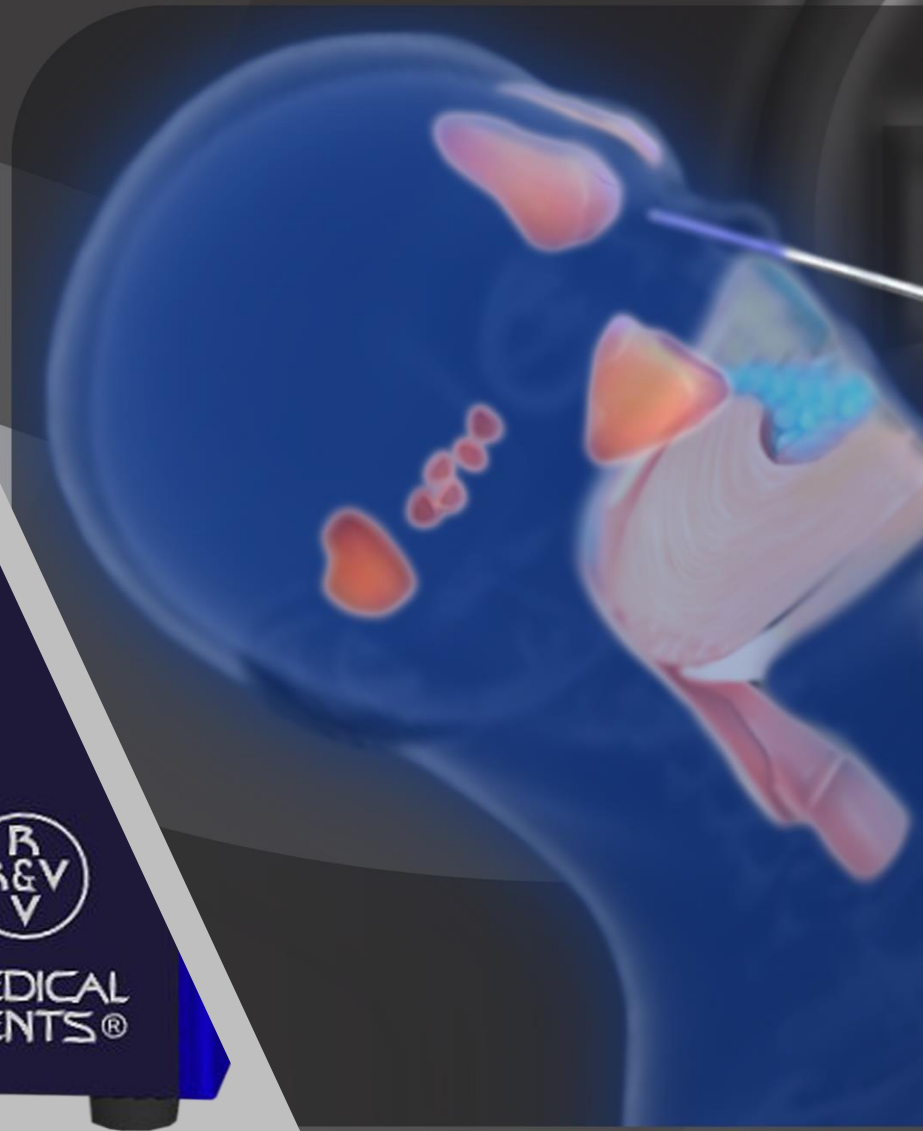

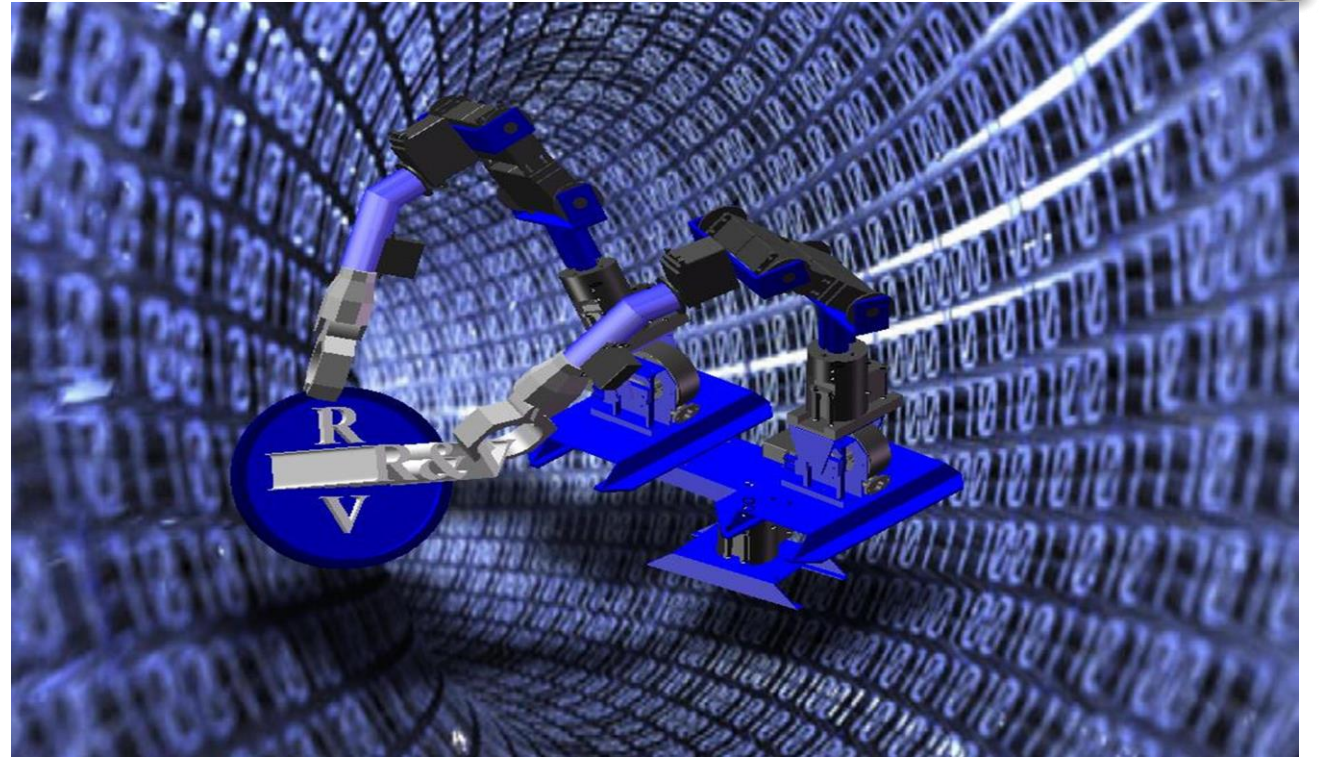
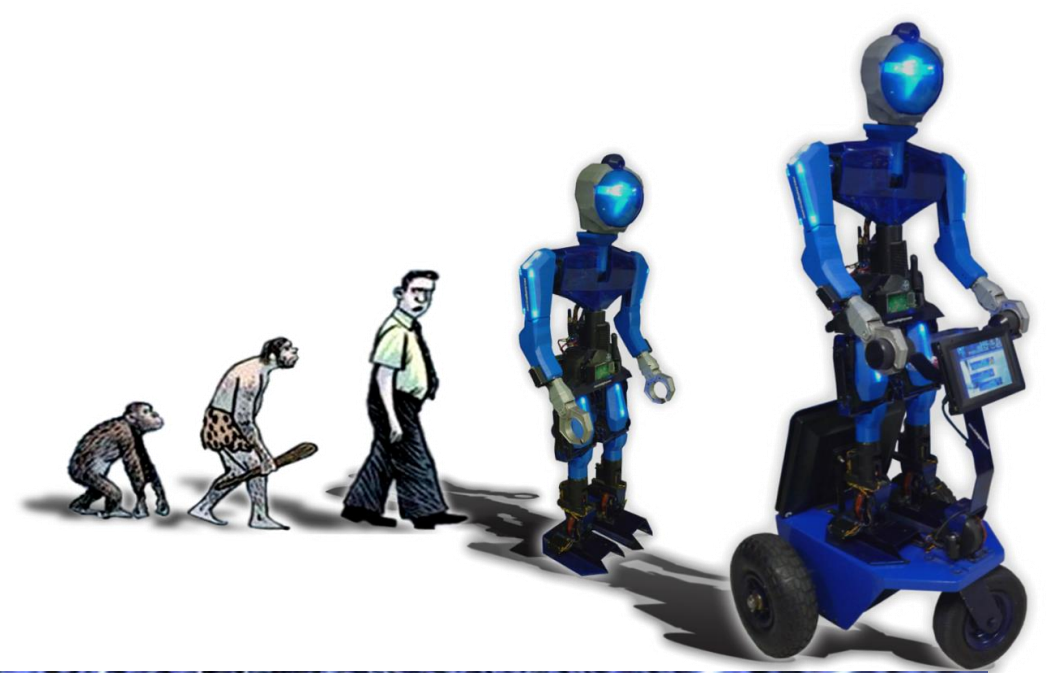
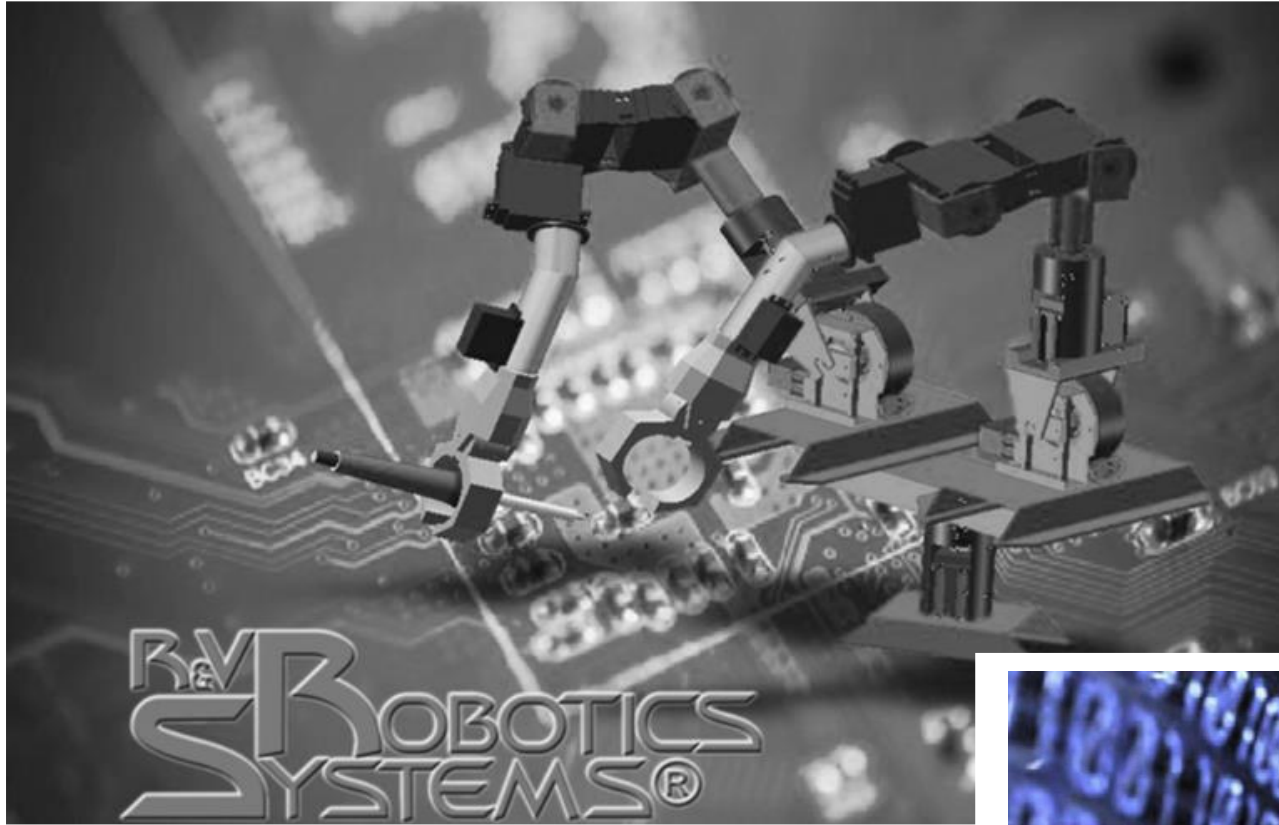

# R&V ROBOTICS SYSTEMS®

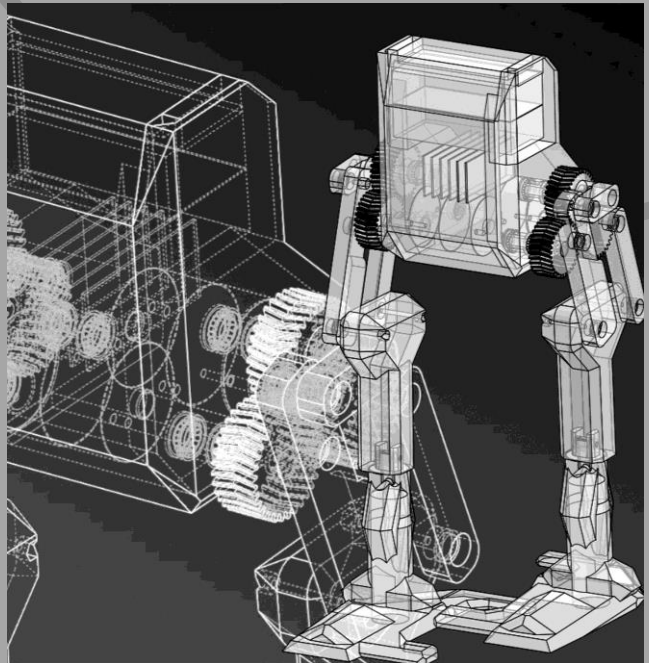
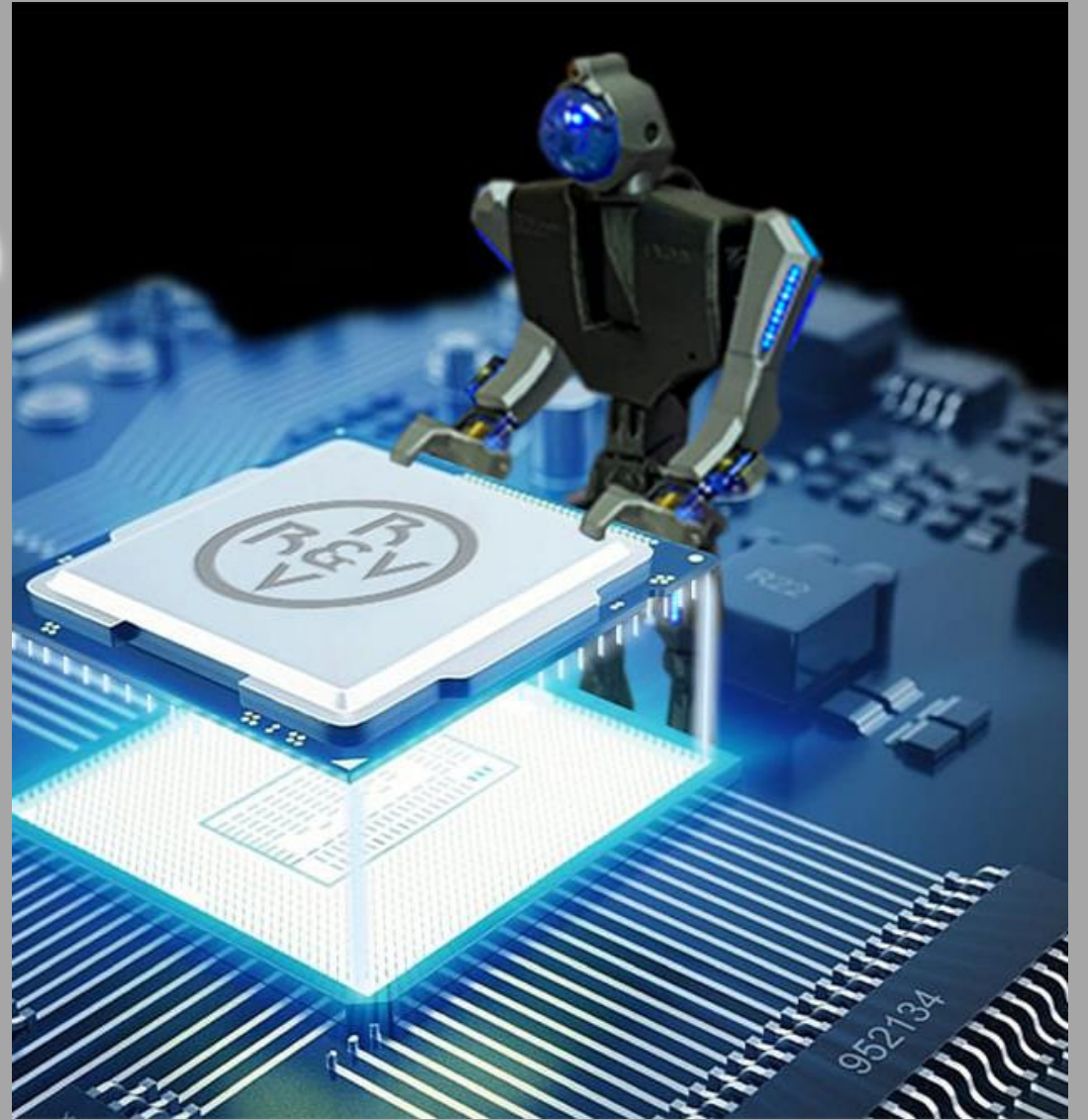

En constante desarrollo de nuevos proyectos para el bienestar de la humanidad!!!

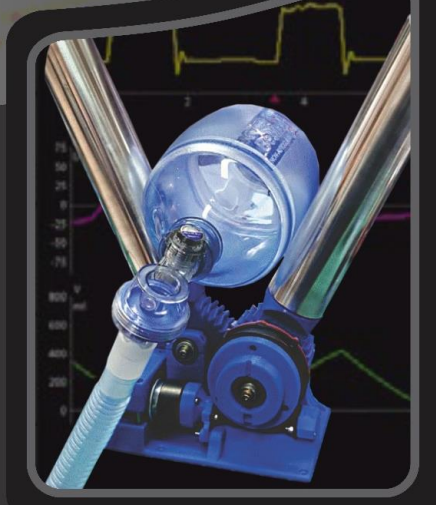
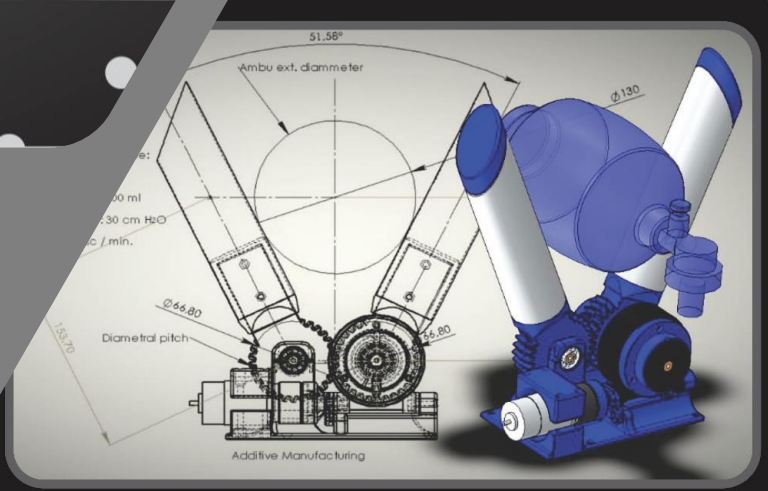
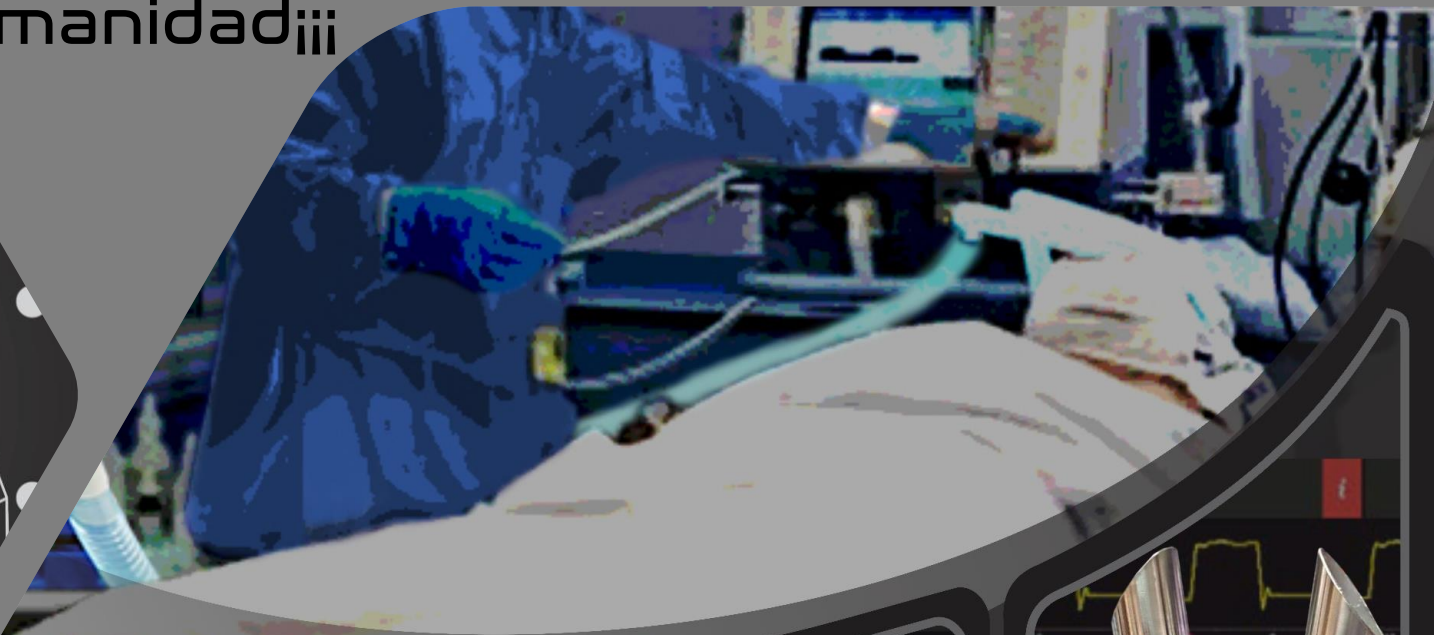

R&V MEDICAL



# R&V HIGH TECHNOLOGY®

CREATING TECHNOLOGY  
FOR THE WORLD  
SINCE 1992!!!



R&V MEDICAL  
EQUIPMENTS®

R&V ROBOTICS  
SYSTEMS®

R&V ELECTRONIC  
DESIGNS®



[www.ryvhightech.com](http://www.ryvhightech.com)  
[www.ryvmedical.com](http://www.ryvmedical.com)

[ventas@ryvmedical.com](mailto:ventas@ryvmedical.com)

[ortopediaryvmedical1@gmail.com](mailto:ortopediaryvmedical1@gmail.com)

[ortopediaryvmedical2@gmail.com](mailto:ortopediaryvmedical2@gmail.com)



(57-1) 2569108

(57-1) 2571163



(+57) 3102324037

(+57) 3154431556